



———— CIVIL ————
INFRASTRUCTURE
—— PLATFORM ——

Threat Modelling - Key Methodologies and Applications from OSS CIP (Civil Infrastructure Platform) Perspective

Dinesh Kumar

Project Manager, Toshiba Software India

SZ Lin (林上智)

TSC Representative, Moxa Inc.

ELCE 2020, 27th Oct.

About Us



- **Dinesh Kumar** <dinesh.kumar@toshiba-tsip.com>
 - Working for Toshiba Software India
 - Works for CIP Security work group
- **SZ Lin (林上智)** <sz.lin@moxa.com>
 - Working for Moxa Inc.
 - Contribute to Linux and other OSS projects
 - **4096R/9561F3F9**
 - 178F 8338 B314 01E3 04FC 44BA A959 B38A 9561 F3F9

Civil Infrastructure

An aerial photograph of San Francisco, California, showing the city's dense urban landscape and the Golden Gate Bridge spanning the Golden Gate Strait. The image is taken from a high angle, looking down on the city and across the water. The sky is clear and blue, and the water is a deep blue. The city's buildings are a mix of heights and colors, with many skyscrapers. The Golden Gate Bridge is a prominent feature, with its two towers and suspension cables clearly visible. The overall scene is a classic view of San Francisco from the air.

The key challenges

- Apply IoT concepts to industrial systems.
- Ensure quality and longevity of products.
- Keep millions of connected systems secure.

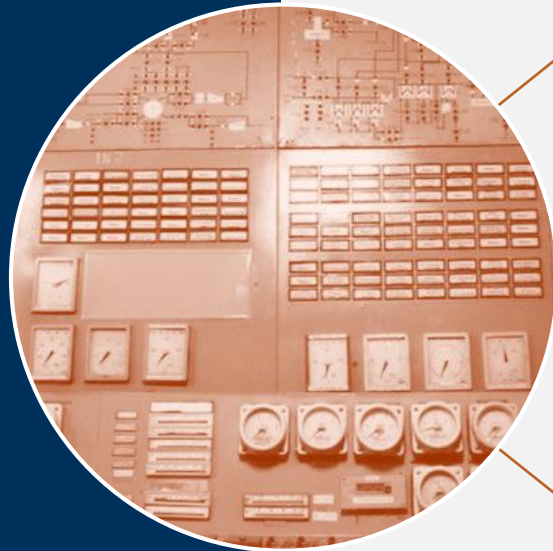

Industrial grade

- Reliability
- Functional Safety
- Real-time capabilities

Sustainability

- Product life-cycles of decades
- Backwards compatibility
- Standards

Security

- Security & vulnerability management
- Firmware updates
- Minimize risk of regressions

CIP is the Solution



Industrial grade

- Reliability
- Functional Safety
- Real-time capabilities

Sustainability

- Product life-cycles of decades
- Backwards compatibility
- Standards

Security

- Security & vulnerability management
- Firmware updates
- Minimize risk of regressions

CIP is the Solution

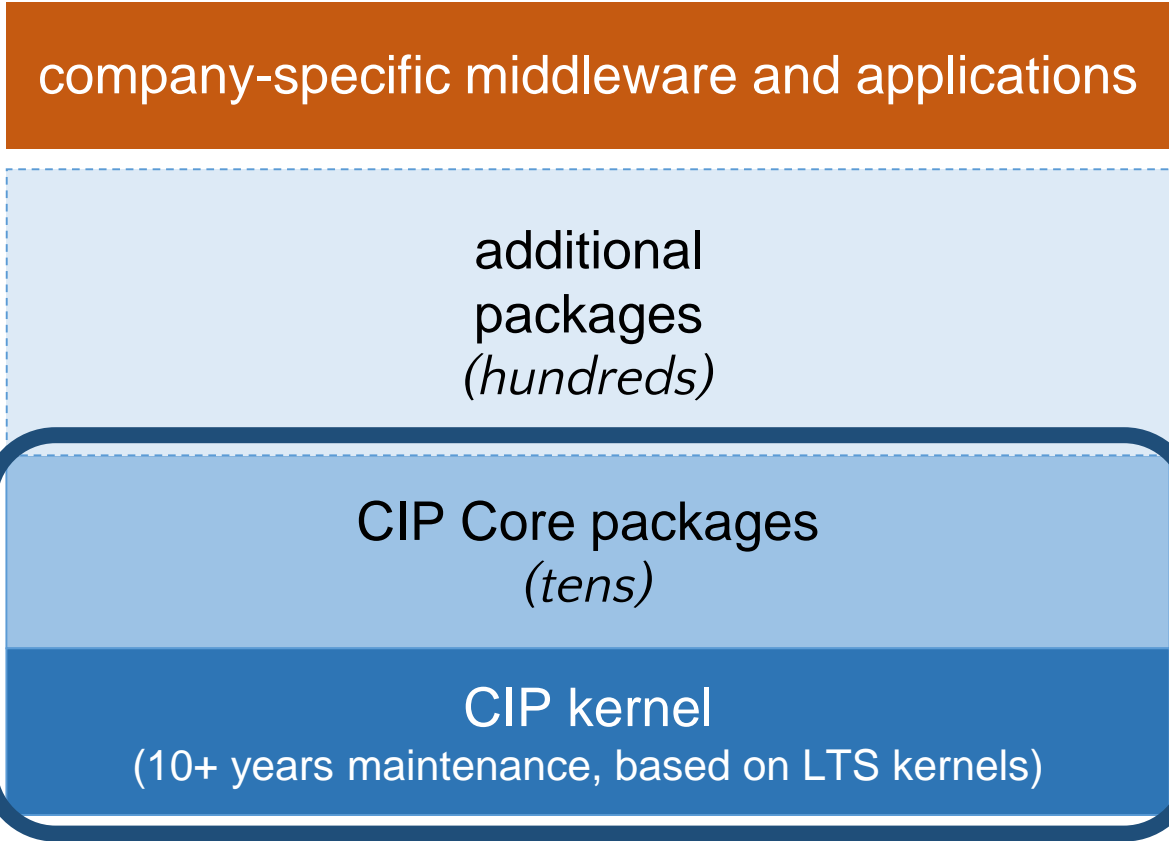

Establishes an “Open Source Base Layer (OSBL)”

The Scope of CIP

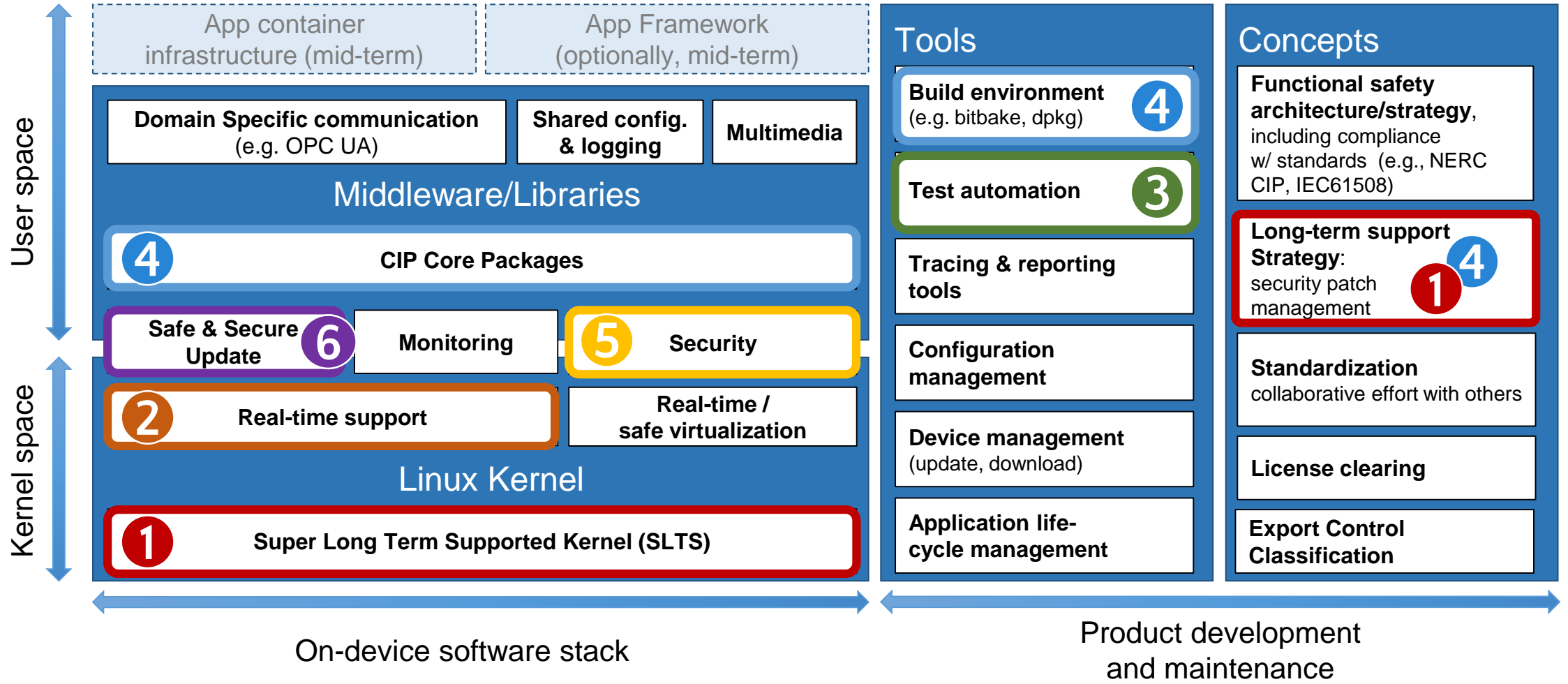

Security Workgroup



- Protect the asset in the civil infrastructure system by **reducing the risk**
- Adapt the international standard - ISA/ IEC 62443 (Industrial Automation & Control System Cybersecurity Standards)

1	2	3	4	5	6	
SLTS kernel	Real-time	Testing	CIP Core	Security WG(*)	Software update WG	(*): Workgroup
✓	✓	✓	✓	✓	✓	Industrial grade
✓		✓	✓		✓	Sustainability
✓		✓	✓	✓	✓	Security

CIP Projects and its scopes

Cybersecurity Risk

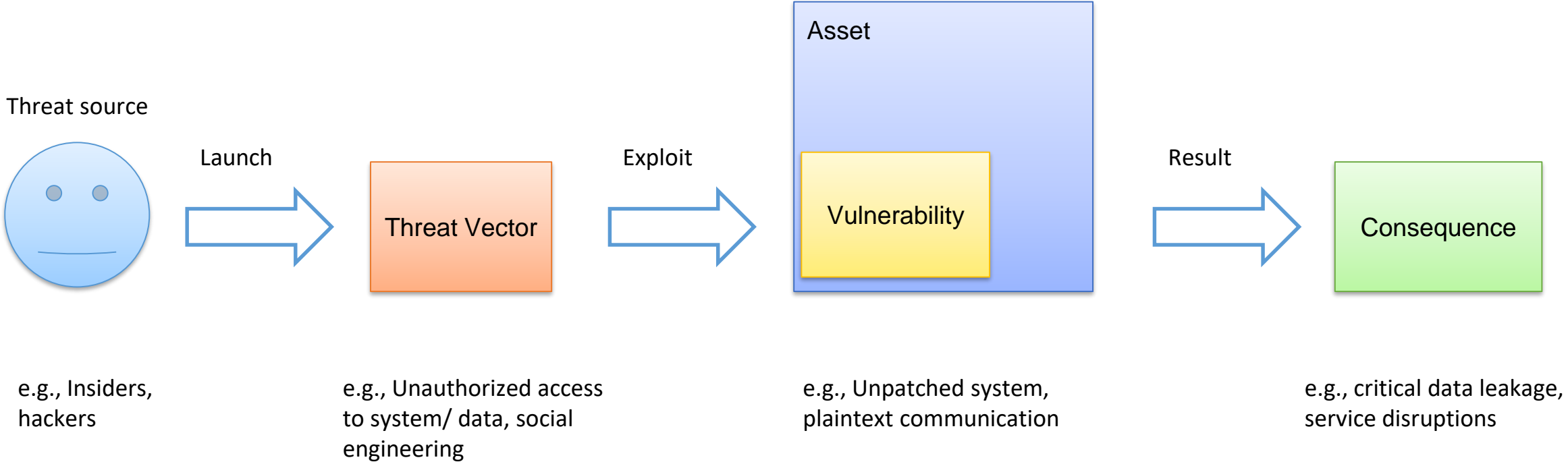

Risk = Threat X Vulnerability X Consequence

What is Threat?



Threat

- Can be initiated by system itself as well as outsider
- Comparatively hard to detect than attacks
- Information may or may not be altered or damaged
- Circumstance that has ability to cause damage
- May or may not be malicious
- Can be intentional or unintentional



src: <https://pixabay.com/zh/illustrations/away-junction-direction-1020200/>



The process of anticipating
“what could go wrong”
and then forecasting
“how it can go wrong.”

General Threat Modelling Objectives



- Attack surface reduction
- Secure default configurations
- Least privilege
- Defense in depth
- Compartmentalization
- Policy compliance

CIP - Objective of Threat Modelling



- Help CIP end users to re-use CIP platform reference threat modelling and build further security on top of it
- Periodically review and update threat model to incorporate newly reported threats
- Reduce the risk of Open Source Base Layer

Threat Modelling Methodologies



Threat source/ viewpoint

Model capability, intent, and targeting for adversarial threats. Find out the actions that the threat agent might conduct.



Threat actions

Model the actions which might be conducted by a threat actor. The common method is STRIDE model developed by Microsoft.



Threat activity

Model the activity which is conducted by a series of threat actions to achieve a desired outcome. The common method is attack tree.



Vulnerability viewpoint

Model the vulnerability within the asset which may exist in the organization. Typically, massive amounts of technical information are essential as indicators.

Key Threat Modelling Methodologies



- STRIDE threat modelling
- Attack trees
- Process for Attack Simulation and Threat Analysis (PASTA)
- Common Vulnerability Scoring System (CVSS)
- Security Cards
- Hybrid Threat Modelling Method (hTMM)

Risk mitigation by Threat Modelling



- **Four ways to reduce risk by using threat analysis report**
 - Redesign to eliminate
 - Takes more time more resources, sometime may not be feasible as component development is out of your control
 - Apply standard mitigations
 - Investigate or re-use how similar threats were mitigated
 - Invent new mitigations
 - It could be riskier if not done properly
 - Adapt compensating controls
 - Take appropriate extra measures in implementation

Data-flow Diagram (DFD) cont...



- Processes
 - are elements that, based on their input, perform actions and/or generate outputs.
- Data stores
 - are sinks or sources of data. Examples are databases or internal storage.
- Data flows
 - represent the flow of information between elements. A data flow can be a protocol specific communication link such as HTTPS or UDP.
- External interactors
 - are elements whose influence should be taken into account, but which are outside the scope of the analysis.
- Trust boundaries
 - divide the elements in the diagram into different trust zones, e.g. elements in open networks vs elements in internal networks

Data-flow Diagram (DFD)



External Entity

- People
- Other systems
- Web portals

Processes

- DLL/.so
- Components
- Services
- exe
- Web services
- Assemblies

Data flow

- Function call
- Network traffic
- RPC

Data Store

- Database
- File
- Registry
- Config files
- Shared memory file

CIP Development Context Diagram

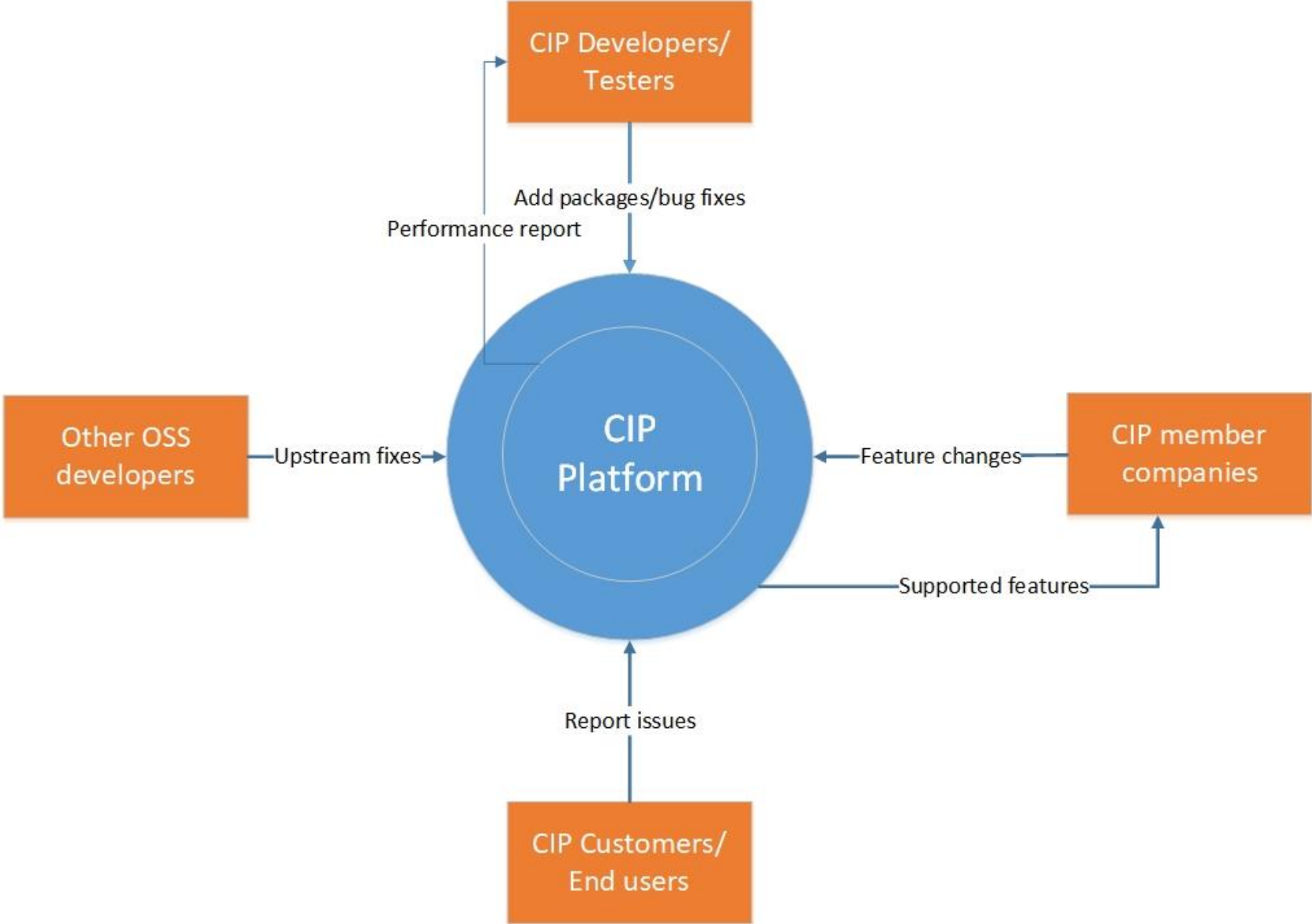

CIP Development DFD

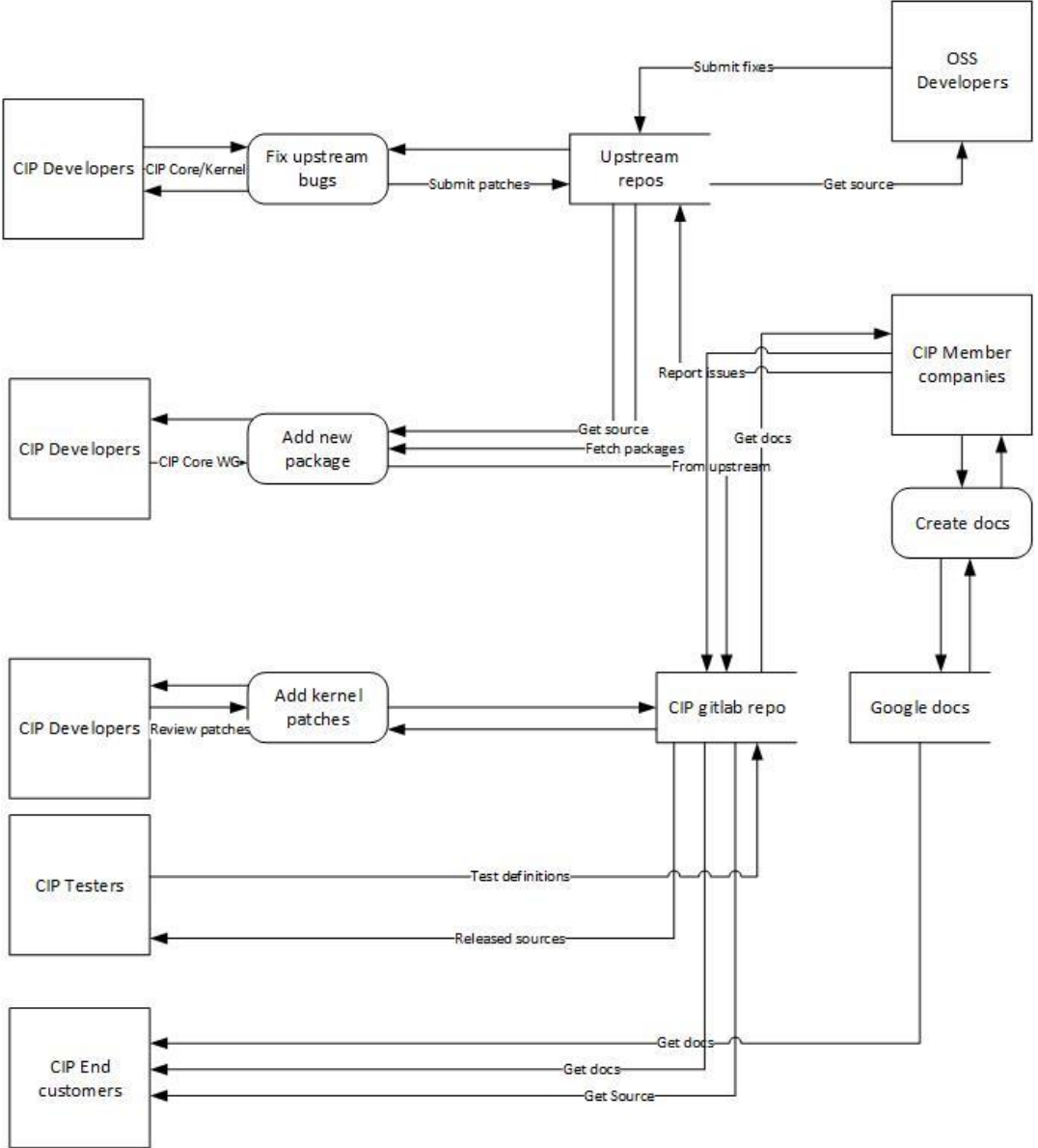

STRIDE: Threats affecting elements



Elements	Spoofing	Tampering	Repudiation	Information Disclosure	Denial of Service	Elevation of Privilege
Data Flows		×		×	×	
Data Stores		×		×	×	
Processes	×	×	×	×	×	×
Interactors	×		×			

CIP as Networking Switch Use Case

- The image depicts ICS reference architecture for Zones and Conduits
- Zone-1 components consist of core components
- Let's try to create DFD and threat model for network switch assuming switch is based on CIP platform

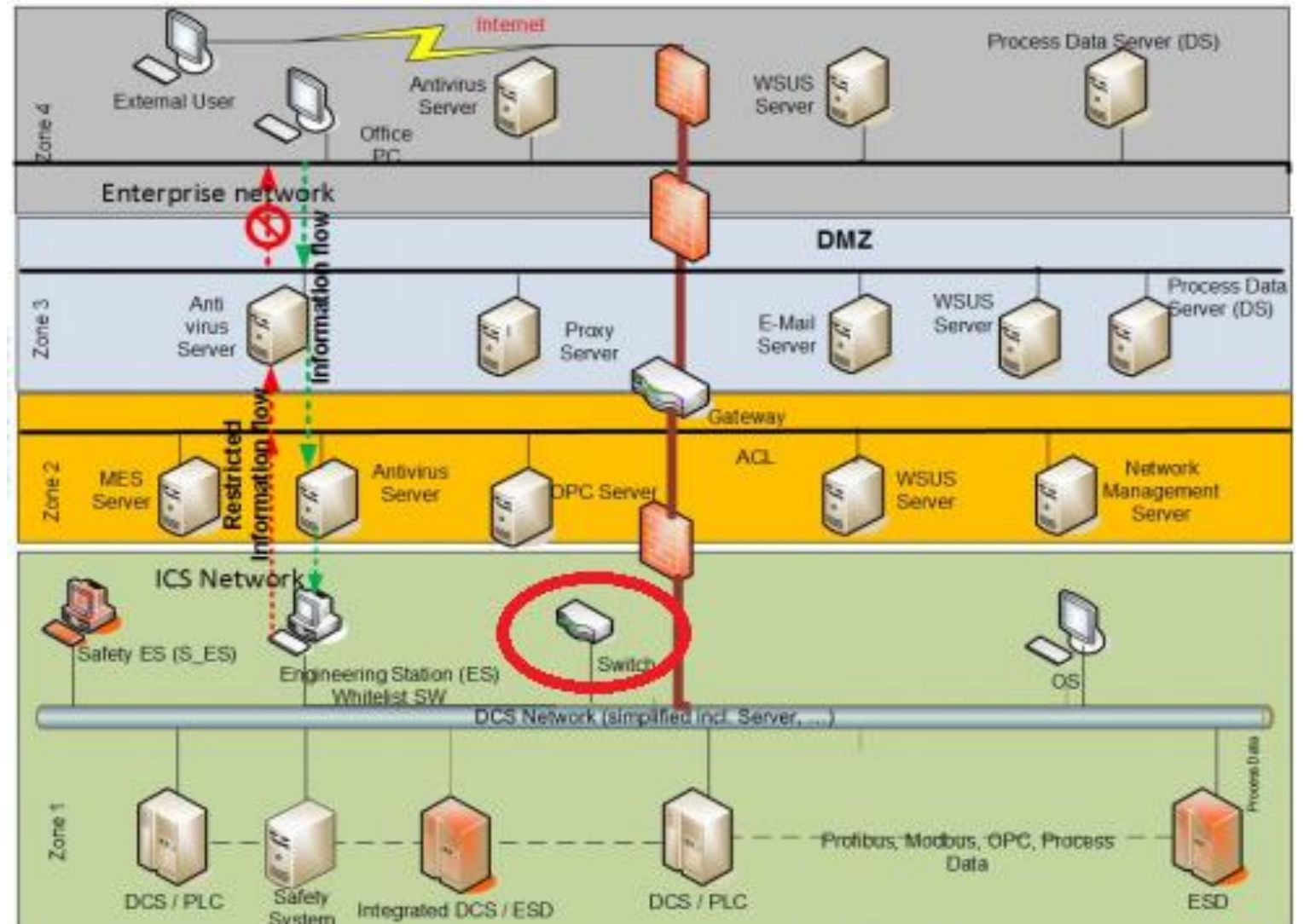

STRIDE: CIP DFD (As Networking Switch)

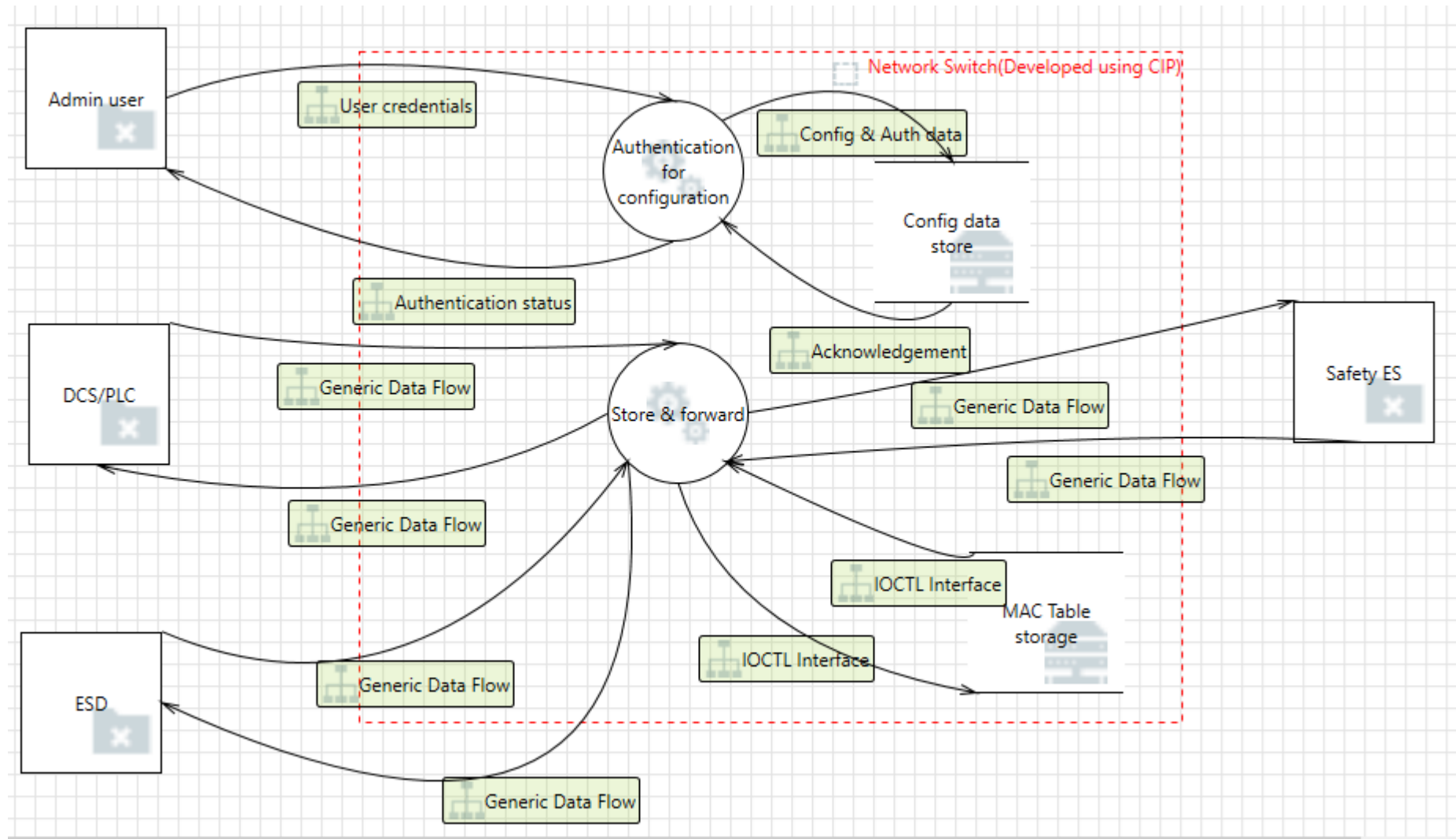

STRIDE: Networking Switch (CIP Threat Analysis View)

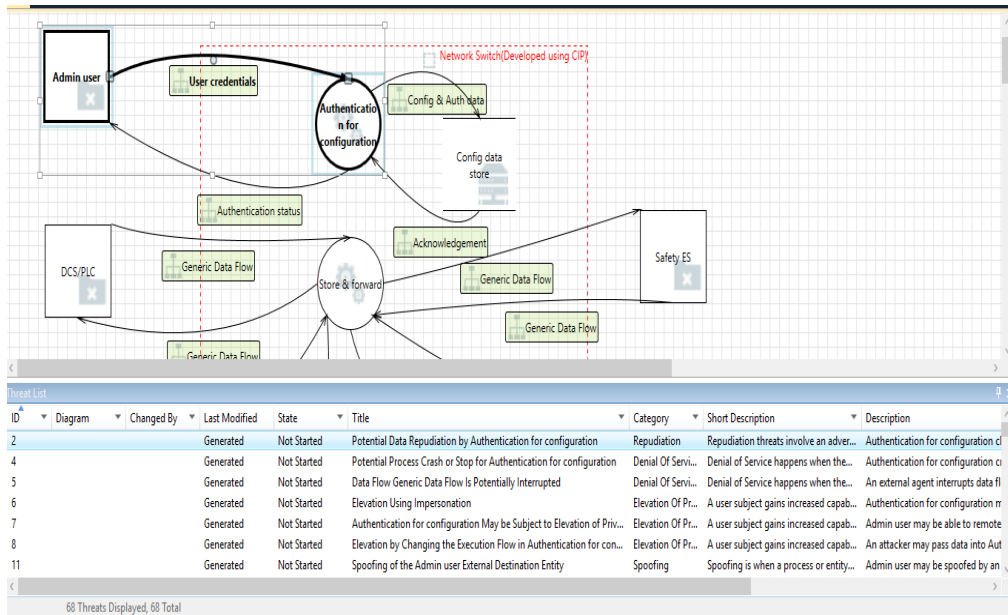

ID	Diagram	Changed By	Last Modified	State	Title	Category	Short Description	Description
2				Generated	Not Started	Potential Data Repudiation by Authentication for configuration	Repudiation	Repudiation threats involve an adver... Authentication for configura...
4				Generated	Not Started	Potential Process Crash or Stop for Authentication for configuration	Denial Of Servi...	Denial of Service happens when the... Authentication for configuration c...
5				Generated	Not Started	Data Flow Generic Data Flow Is Potentially Interrupted	Denial Of Servi...	Denial of Service happens when the... An external agent interrupts data fl...
6				Generated	Not Started	Elevation Using Impersonation	Elevation Of Pr...	A user subject gains increased capab... Authentication for configuration n...
7				Generated	Not Started	Authentication for configuration May be Subject to Elevation of Priv...	Elevation Of Pr...	A user subject gains increased capab... Admin user may be able to remote...
8				Generated	Not Started	Elevation by Changing the Execution Flow in Authentication for con...	Elevation Of Pr...	A user subject gains increased capab... An attacker may pass data into Aut...
11				Generated	Not Started	Spoofing of the Admin user External Destination Entity	Spoofing	Spoofing is when a process or entity... Admin user may be spoofed by an...

Threat Properties

D: 2 Diagram: Status: Not Started Last Modified: Ge

Title:

Category: Repudiation

Description:

Justification:

Interaction:

Priority: High

Threat Properties Notes - no entries

Threat Properties 🔍 ✕

ID: 2 Diagram: Status: Not Started Last Modified: Generated

Title:

Category: Repudiation

Description:

Justification:

Interaction:

Priority: High

CIP DFD (As PLC Use Case)

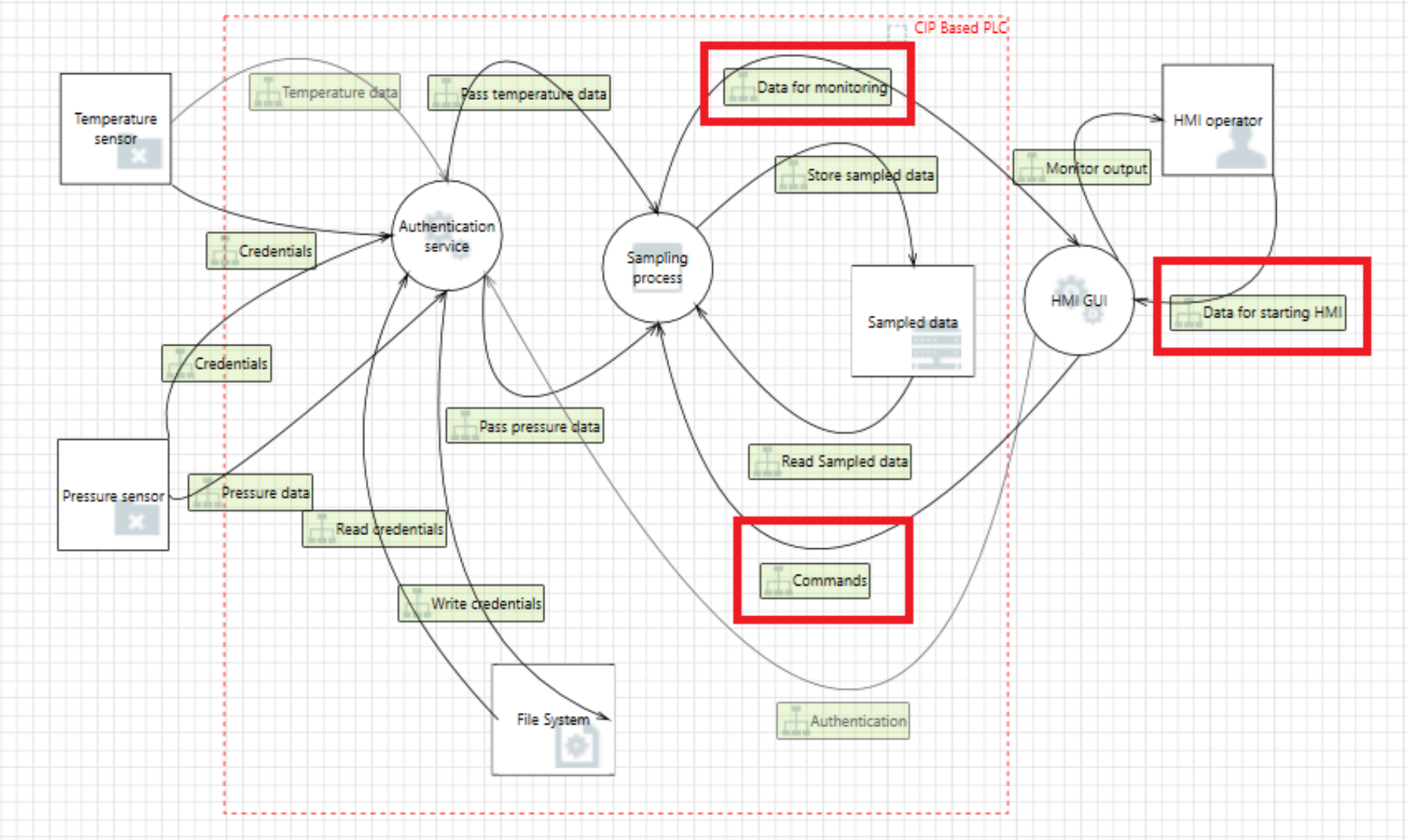

STRIDE: Threat Model Analysis Report



Interaction: Commands

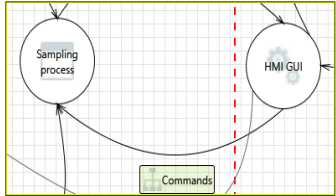

1. Virtual Machine Process Memory Tampered [State: Not Started] [Priority: High]

Category: Tampering

Description: If HMI GUI is given access to memory, such as shared memory or pointers, or is given the ability to control what Sampling process executes (for example, passing back a function pointer), then HMI GUI can tamper with Sampling process. Consider if the function could work with less access to memory, such as passing data rather than pointers. Copy in data provided, and then validate it.

Justification: <no mitigation provided>

2. Elevation Using Impersonation [State: Not Started] [Priority: High]

Category: Elevation Of Privilege

Description: Sampling process may be able to impersonate the context of HMI GUI in order to gain additional privilege.

Justification: <no mitigation provided>

- Threat Model Analysis Report reveals about the missing security measures in existing models
- For each missing point, counter measures information should be provided or security measures should be taken
- At each design change or new package addition this step should be repeated

Interaction: Data for monitoring

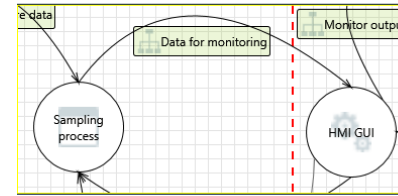

32. Replay Attacks [State: Not Started] [Priority: High]

Category: Tampering

Description: Packets or messages without sequence numbers or timestamps can be captured and replayed in a wide variety of ways. Implement or utilize an existing communication protocol that supports anti-replay techniques (investigate sequence numbers before timers) and strong integrity.

Justification: <no mitigation provided>

33. Collision Attacks [State: Not Started] [Priority: High]

Category: Tampering

Description: Attackers who can send a series of packets or messages may be able to overlap data. For example, packet 1 may be 100 bytes starting at offset 0. Packet 2 may be 100 bytes starting at offset 25. Packet 2 will overwrite 75 bytes of packet 1. Ensure you reassemble data before filtering it, and ensure you explicitly handle these sorts of cases.

Interaction: Data for starting HMI

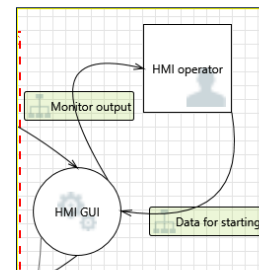

44. Elevation Using Impersonation [State: Not Started] [Priority: High]

Category: Elevation Of Privilege

Description: HMI GUI may be able to impersonate the context of HMI operator in order to gain additional privilege.

Justification: <no mitigation provided>

45. Spoofing the HMI operator External Entity [State: Not Started] [Priority: High]

Category: Spoofing

Description: HMI operator may be spoofed by an attacker and this may lead to unauthorized access to HMI GUI. Consider using a standard authentication mechanism to identify the external entity.

STRIDE: Standard Mitigations



Threat	Security property	Mitigation methods	CIP feature to address standard Threats
Spoofting	Authentication	-Kerberos authentication -PKI Systems, SSL, TLS -Digital signatures	-shadow, pam, - libpam_google_authenticator, -openssl
Tempering	Integrity	-MAC(Mandatory Access Control) -ACLs -Digital Signatures -Checksum	-acl -openssl(digital signature verification) -Sha256, sha512
Repudiation	Non Repudiation	-Secure logging & auditing -Digital signatures	-auditd -rsyslog
Information disclosure	Confidentiality	-Encryption -ACLs	-openssl -acl
Denial of service	Availability	-ACLs -Security policies -Quota	-pam -openssh -acl
Elevation of privileges	Authorization	-ACLs -Group of Role membership -Input Validation	-acl -security policies published via application rules

Generic Attack Tree example

- Root node of the tree is the global goal of the attacker
- Each node represents one attack
- An attack tree defines a collection of possible attacks
- An attack described in a node may require one or more of many attacks described in child nodes to be satisfied

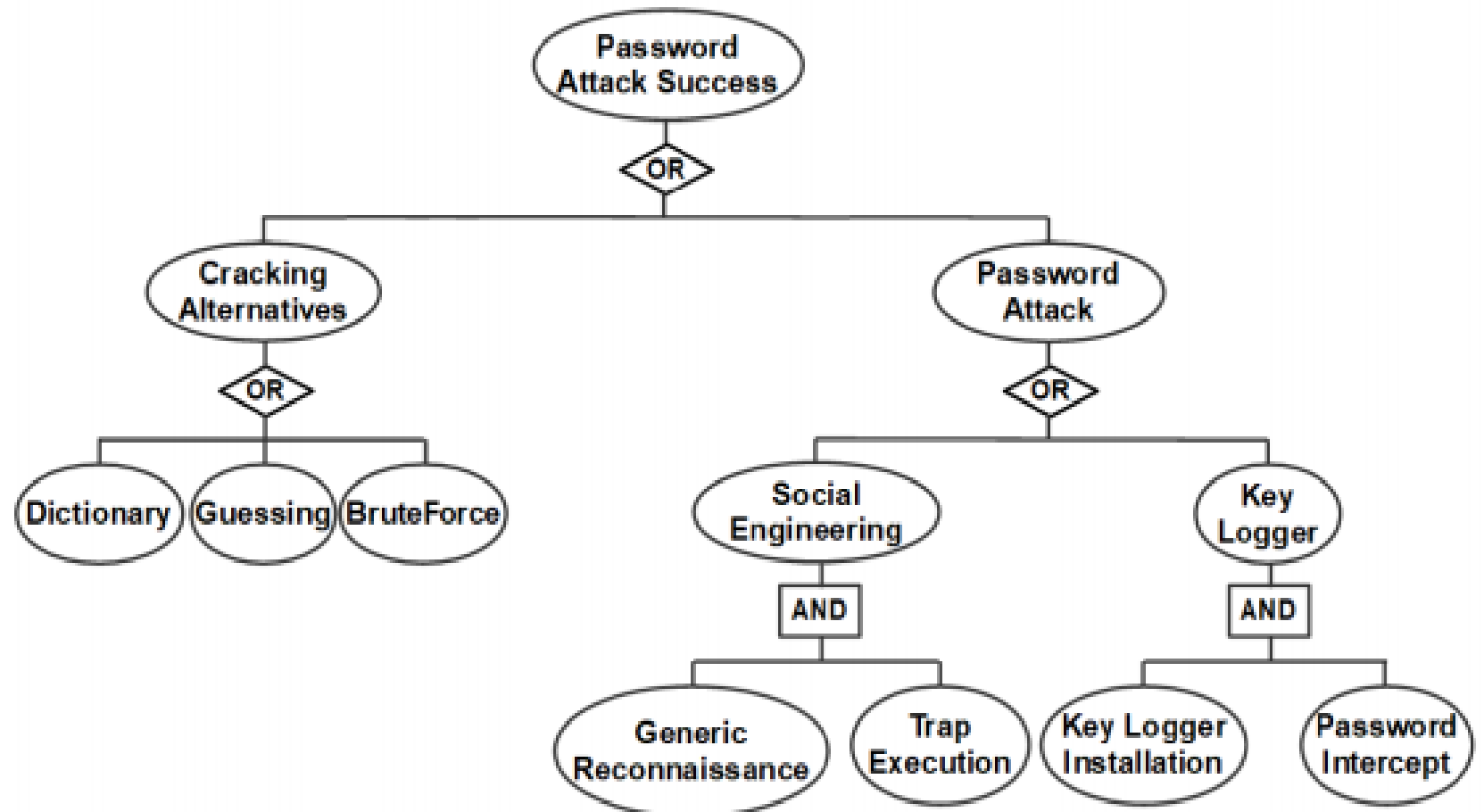

Attack Tree for CIP Repositories

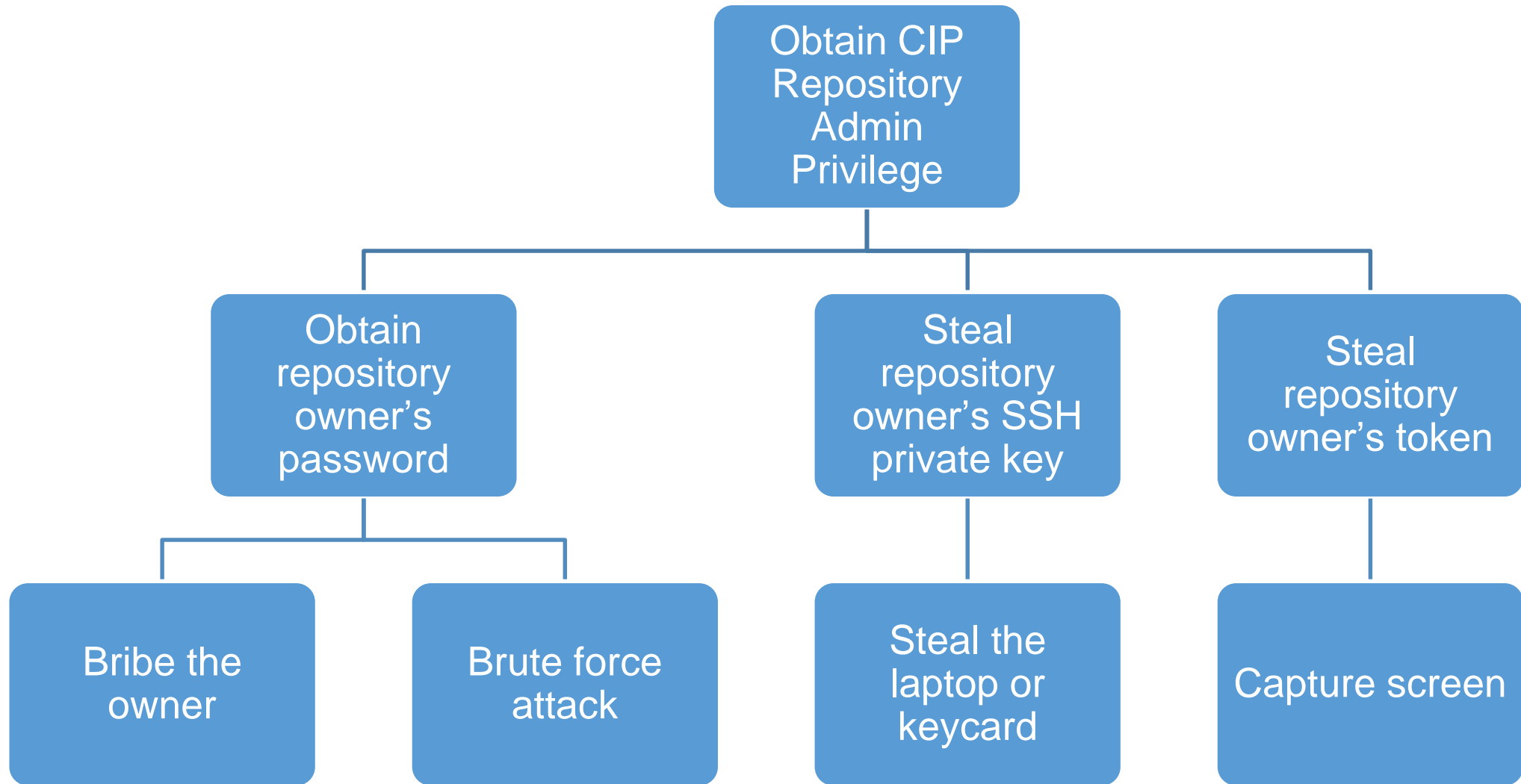

Attack Tree for CIP based systems

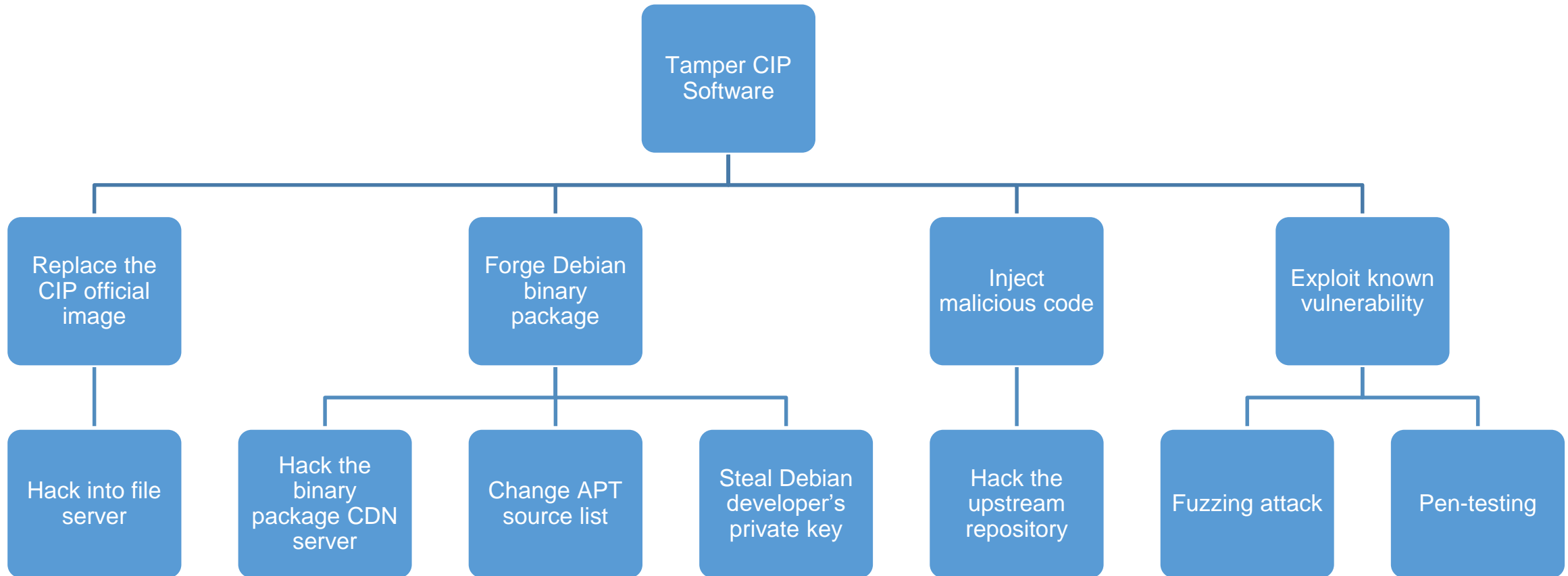

Validating Threat Models



- Validate whole threat model
 - Does diagram match the final code or final system implementation?
 - Are all threats enumerated
 - Minimum: STRIDE per element that touches a trust boundary
 - Has test/QA reviewed the model
 - Tester often finds issues with threat models or uncover something not considered during threat modelling
 - Is each threat mitigated
 - Are mitigations done right

Next Step for CIP Threat Modelling

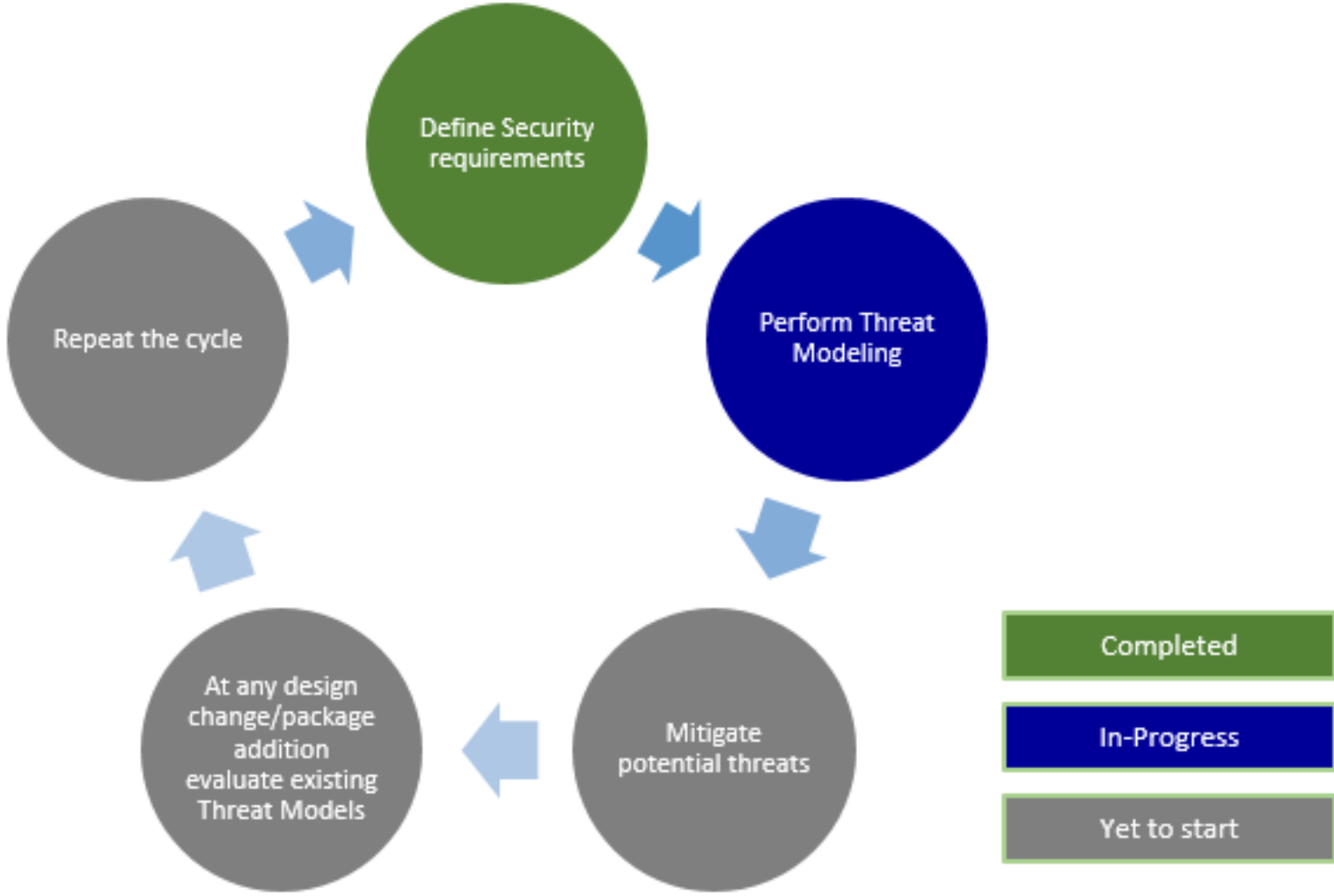

Reference for CIP resources



- CIP Home page
 - <https://www.cip-project.org/>
- CIP Work Groups wiki page
 - <https://wiki.linuxfoundation.org/civilinfrastructureplatform/start>
- CIP membership page
 - <https://www.cip-project.org/about/join>
- CIP Core gitlab
 - <https://gitlab.com/cip-project/cip-core>
- CIP Kernel gitlab
 - <https://gitlab.com/cip-project/cip-kernel/linux-cip>
- CIP Documents
 - <https://gitlab.com/cip-project/cip-documents>

Threat Modelling Tools



- **Draw.io libraries for threat modelling**
 - <https://github.com/michenriksen/drawio-threatmodeling>
- **OWASP-Threat-Dragon**
 - <https://threatdragon.org/login>
- **threatspec**
 - <https://threatspec.org/>
- **pytm**
 - <https://github.com/izar/pytm>
- **Microsoft Threat Modelling Tool**
 - <https://docs.microsoft.com/en-gb/azure/security/develop/threat-modeling-tool>

CIP Talks at ELCE, and CIP Mini Summit



- **October 26**
 - CIP Kernel: [Upstream first is our principle](#)
- **October 28**
 - CIP Security: [The international effort to establish Base Layer](#)
- **October 27**
 - CIP Security: [Threat Modelling](#)
- **October 30**
 - CIP [Mini-summit](#)

Please Visit CIP Virtual Booth!



“CIP mini-summit” will be held on Oct. 30th (Frid)”
thank you!

Join us

CIP for sustainable Smart Cities with Open Source Software



———— CIVIL ————
INFRASTRUCTURE
———— PLATFORM ————

RENEASAS

SIEMENS

TOSHIBA

CodeThink

cybertrust

HITACHI
Inspire the Next

MOXA®

Plat'Home
There, we are. Internet of Things

Question?



Thank you



— CIVIL —
INFRASTRUCTURE
— PLATFORM —

References



- NIST Special Publication 800-30r1 Guide for Conducting Risk Assessments
 - <https://nvlpubs.nist.gov/nistpubs/Legacy/SP/nistspecialpublication800-30r1.pdf>
- NIST Special Publication 800-39 Managing Information Security Risk
 - <https://nvlpubs.nist.gov/nistpubs/Legacy/SP/nistspecialpublication800-39.pdf>
- Secure Code, Threat modeling sessions
 - <https://www.youtube.com/watch?v=gDtS68DPm6Q>